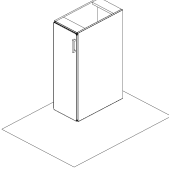
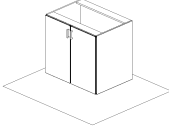
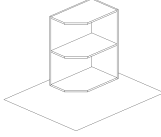
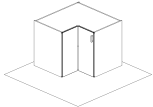
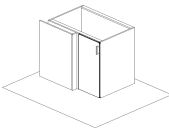
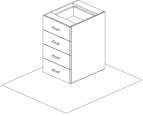
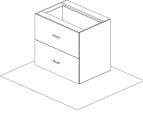
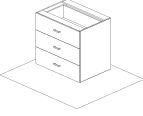
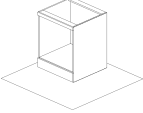

# Esipak order form

(easy self installed pre assembled kitchens)

One cabinet with your order (minimum 4 cabinets) can be altered in width to ensure cabinets will fit. Simply choose the closest larger cabinet from list, cross out existing dimension and write in required dimension. Any other cabinets can be altered or custom made but will incur an extra charge.

## Floor Cabinets 580 deep (includes door) x 720mm high (866mm high with kick 900mm with top)

Code	Description		Colour	Melamine	2 Pak	Quantity	Price
<b>Single Door</b> F250	250mm floor cabinet						
F300	300mm floor cabinet						
F400	400mm floor cabinet						
F450	450mm floor cabinet						
<b>Double Door</b> F600	600mm floor cabinet						
F800	800mm floor cabinet						
F900	900mm floor cabinet						
FES	400mm open shelf						
<b>Corner Cabinets</b>							
FC900	900x900mm corner cabinet (317 wide doors)						
FCV950	950x630mm void corner cabinet (317 wide door)						
<b>Drawers</b>							
FD4 450	450mm 4 drawer cabinet						
FD2 800	800mm 2 drawer cabinet						
FD3 800	800mm 3 drawer cabinet						
UB600	600mm standard under bench oven cabinet						

## Wall Cabinets 320 deep x 600mm high (depth includes door)

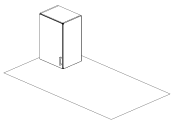
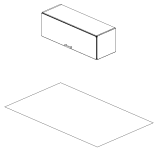
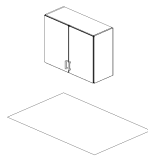
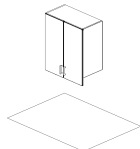
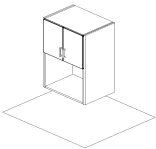
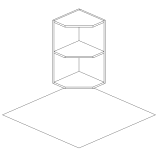
Code	Description		Colour	Melamine	2 Pack	Qty	Price
<b>Single Door</b> W250	250mm wall cabinet						
W300	300mm wall cabinet						
W400	400mm wall cabinet						
W450	450mm wall cabinet						
W900F	900Wx300Hx320deep Fridge overhead cabinet with flap door						
<b>Double Door</b> W600	600mm wall cabinet						
W800	800mm wall cabinet						
W900	900mm wall cabinet						
RH600	600mm range hood cabinet. To suit supplied range hood specifications.						
WMW633	Microwave cabinet. Includes colour panels.						
WES320	320mm wall open end shelves.						

## Pantries & Wall Oven 600deep (includes door) x 1954mm high (2100mm high with kick)

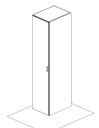
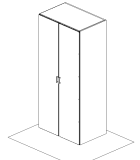
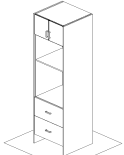
<b>Single Door</b> P450	450mm pantry						
P600	600mm pantry						
<b>Double Door</b> P900	900mm pantry						
WO633	633mm wall oven tower. Includes colour panels. To suit 600x600mm oven.						

**Panels and Kicks** 2 Pak panels painted one side and one edge unless specified. Kicks painted one side only.

Code	Description	Colour	Melamine	2 Pak	Qty	Price
K2400	2400x146mm kick					
K1200	1200x146mm kick					
FP580	866Hx580mm end panel 1 x 866mm edged					
FP1200	866Hx1200mm end panel 2 x 866 edged					
FP2400	866Hx2400mm end panel 2 x 866 edged					
TEP2100	2100Hx602mm end panel 1 x 2100 edged					
TEPD2100	2100Hx602mm end panel for 2 pack panels that require paint 2 sides e.g. fridge panels 1 x 2100 edged					
WEP320	600Hx320mm wall end panel 1 x 600 + 1 x 320 edged					
FF866	866Hx150Dx16Wmm floor filler panel 1 x 866 edged					
WF	600Hx16WMM wall filler panel 1 x 600 + 1 x 320 edged					
TF2100	2100Hx150Dx16Wmm tall filler panel 1 x 2100 edged					

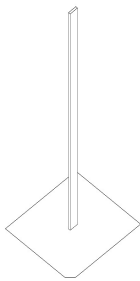
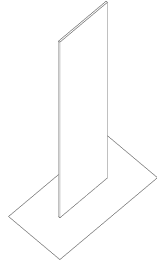
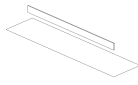

**Bench Tops:** Simply draw your top sizes as shown on the Esipak planning grid. Standard bench top sizes are 600mm and 900 wide. Maximum length 3600mm Sold per meter (see price list).

Need assistance ordering or designing your Esipak kitchen? Contact us and we will be happy to help

Need advise installing your Esipak kitchen? Esipak comes with full installation instructions. Plus encounter a problem, just give us a call and we will talk you through it

Kitchens R Us  
Ph 5493 6075  
Fax 5493 5430